

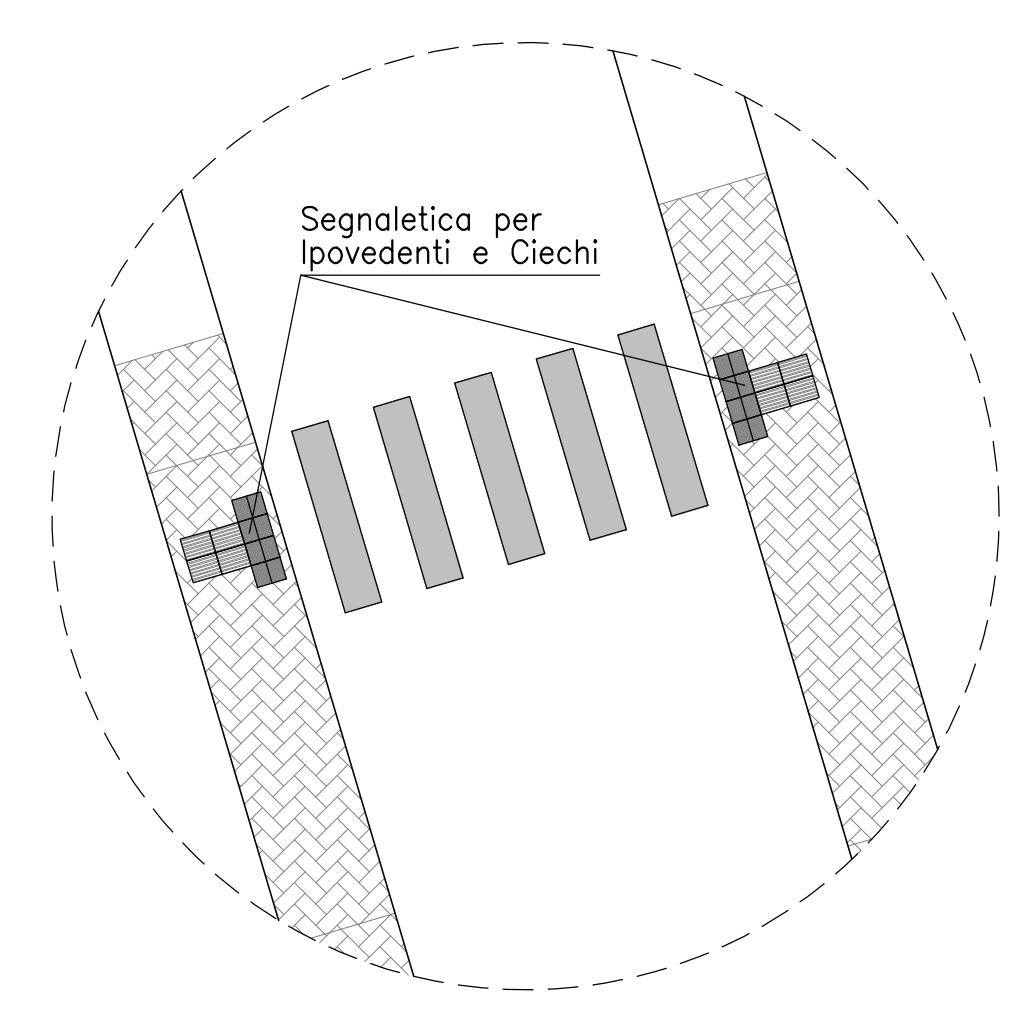

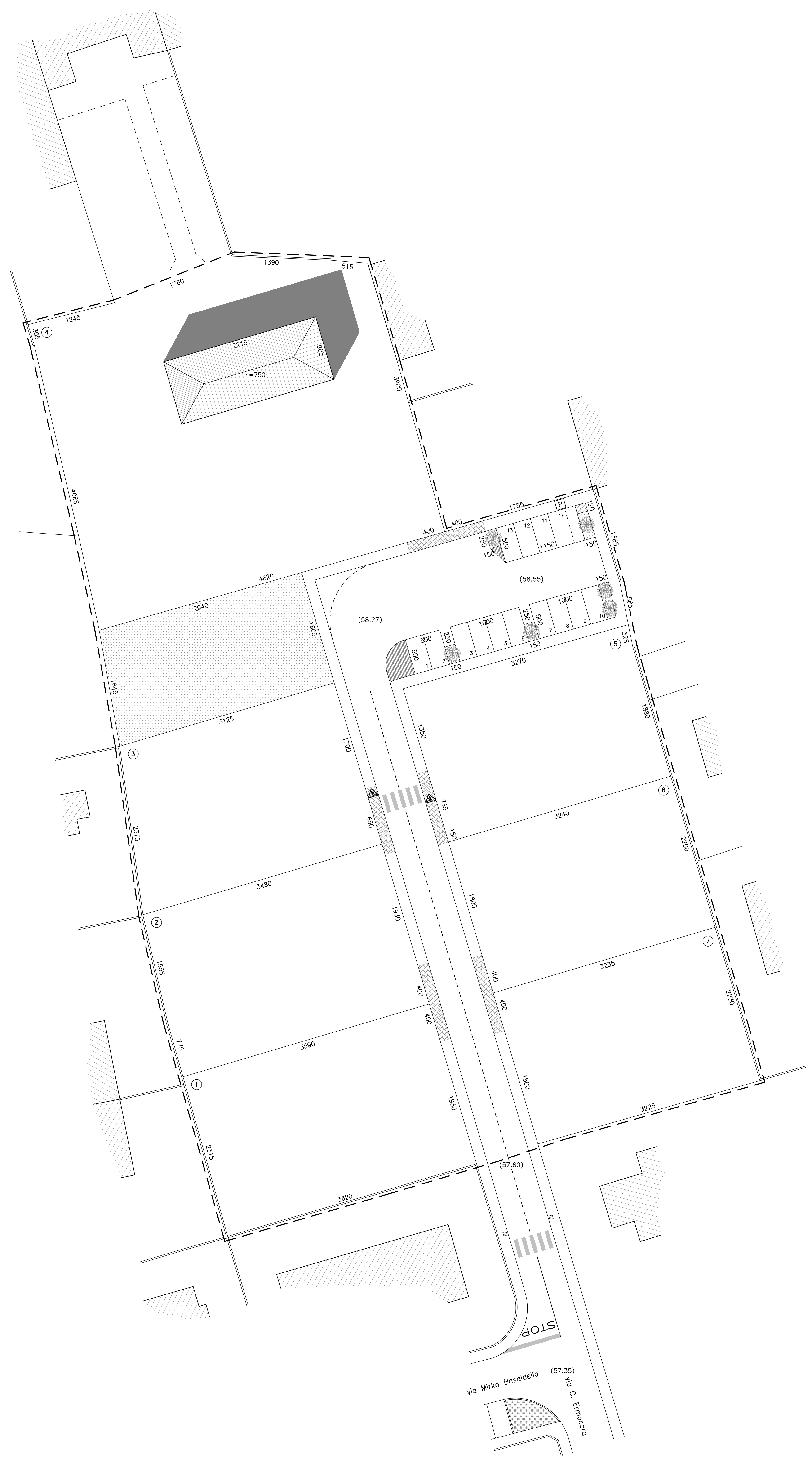



IL PROPRIETARI

IL TECNICO



PARTICOLARE ATTRAVERSAMENTO  
 Scala 1:100

LEGENDA

-  PASSAGGIO PEDONALE
-  VERDE PUBBLICO
-  MARCIAPIEDE RIBASSATO
-  PARCHEGGIO PER PORTATORI DI HANDICAP
-  QUOTE ALTIMETRICHE SLM
-  LIMITE COMPARTO